



*Great sound  
from Barcelona  
since 1972*

[www.amateaudio.com](http://www.amateaudio.com)

## User's manual

# S218W

# NÍTiD

*#purelynitid*

February 2024

Amate Audio S.L.

EXPORT & CUSTOMER SERVICE  
Perpinyà, 25 · Polígon Industrial Nord  
08226 Terrassa · Barcelona – SPAIN  
T. +34 93 735 65 65  
[export@amateaudio.com](mailto:export@amateaudio.com)

R&D, FACTORY AND MANAGEMENT  
Violinista Vellsolà, 18  
08222 Terrassa · Barcelona – SPAIN  
T. +34 93 736 23 90  
[info@amateaudio.com](mailto:info@amateaudio.com)

## **Safety Instructions**

1. All safety instructions must be read before using this device.
2. Keep and follow these instructions
3. Heed all warnings
4. The exclamation mark in the triangle indicates internal components which if replaced can affect safety.
5. The lightning symbol within the triangle indicates the presence of dangerous uninsulated voltages.
6. Only clean the device with a dry cloth.
7. Do not block any ventilation openings. Install in accordance with the manufacturer's instructions.
8. Do not install the device near heat sources such as radiators, heaters or other heat-emitting elements.
9. Protect the power cord from being walked on or pinched, particularly at plugs, convenience receptacles, and the point where they exit from the apparatus
10. The equipment must be repaired by qualified technical service personnel when:
  - A. The mains supply cable is damaged, or
  - B. Any object or liquid has damaged the device; or
  - C. The equipment does not function normally or correctly; or
  - D. The equipment has been exposed to the rain; or
  - E. The chassis is damaged
11. Disconnect the device in the case of electric storms or during long periods of disuse.
12. **WARNING** – To reduce the risk of fire or electric shock, do not expose this device to rain or moisture
13. The equipment shall not be exposed to dripping or splashing and no objects filled with liquids, such as vases, shall be placed on the device.
14. For hanging and installation, use manufacturer recommended accessories only.

## 1. INTRODUCTION

### 1.1. General

Amate Audio would like to thank you for your confidence in our NÍTID Series. We suggest you to carefully read the following instructions in order to obtain the best results in performance.

### 1.2. Features and presentation

#### S218W

- Self-powered subwoofer
- XLR electronically balanced input & output
- AC PowerCon input & link
- 2500 W class D amplifier
- 24-bit AD/DA converters, 48 kHz sampling rate
- DSP Controls (presets, parametric EQs, delay, mute, gain, polarity and limiter)
- ECO-mode available: automatic standby mode controlled by the input signal
- Amplifier self-diagnostics: input and output level, temperature, limiter active
- 2 x 18" woofer with 4" voice coil

### 1.3. Presets on S218W

The S218W includes several manufacturer presets for different types of applications.

#### 1.3.1. As extension on floor for NÍTID S top models

The S218W provides an extension of the bandwidth in the low end for the Nítid S systems, down to 30 Hz.

This extension is done at 90 Hz crossover point.

Model: S6 / S26  
Preset: [HPF90]

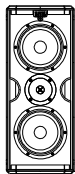

+

Model: S10  
Preset: [HPF90]

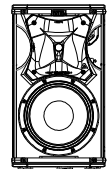

+

Model: S218W  
Preset: [S-ALIGNED]

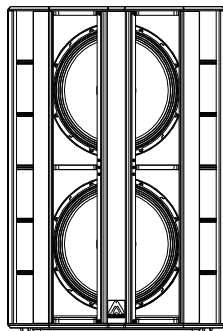

Model: S218W  
Preset: [S-ALIGNED]

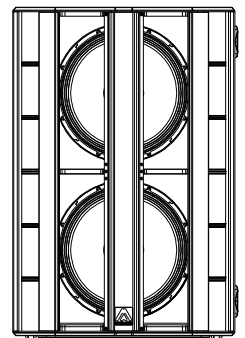

Model: S12 / S15  
Preset: [HPF90]

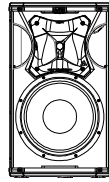

+

Model: S218W  
Preset: [S-ALIGNED]

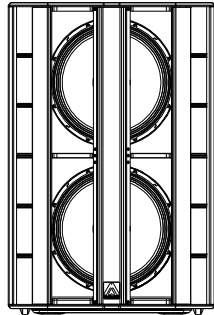

### SYSTEM ALIGNMENT

The system S6 / S26 / S10 / S12 / S15 + S218W is pre-aligned from the factory. Do not forget to add the geometric delay depending on the configuration used.

#### 1.3.2. General purpose (Standard) presets

These presets can be used to match the S218W with any other cabinet. These presets are not pre-aligned, so a time alignment with the top model satellite is recommended. There are three standard presets, and they are defined by the Low Pass Filter, which can be selected at 80, 90 or 100 Hz:

LPF80 Standard  
LPF90 Standard  
LPF100 Standard

#### 1.3.3. Cardioid presets

The S218W enables the combination of three or multiple of three subwoofer cabinets in an array to provide exceptional directivity at low frequencies. High directivity at low frequencies has two main effects on the sound field: firstly, the low frequency level behind the subwoofer cabinets is greatly reduced; secondly, in closed venues the diffuse sound field at low frequencies is reduced so the low frequency reproduction is much more precise.

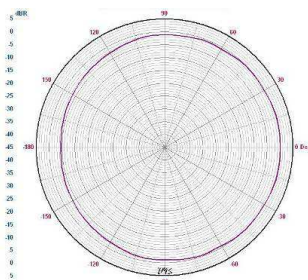

The typical operating range of a traditional subwoofer tends to be like a monopole, i.e. tends to radiate with the same energy in all directions. This behaviour implies that the control of radiation at low frequencies is very difficult because the wavelengths are very large compared to the size of the source (8.5 m at 40 Hz).

**Fig. 1.** Traditional polar pattern of a subwoofer at 40 Hz

To increase the directivity at low frequencies we must transform the omnidirectional performance into a cardioid performance. This can only be achieved by various sources, arranged in a certain position, to which we apply a specific phase, filtering and delay. That is, we need to reproduce two signals with the same frequency and similar amplitude which will have a difference in phase of approximately 180° at a certain point of the sound field.

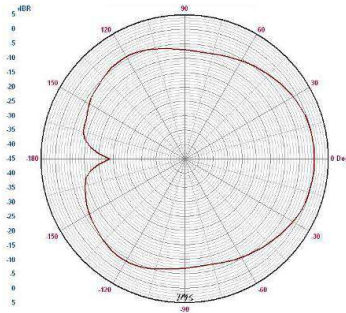

If the phases and delays are well calculated, the result is a system, in which we cancel the energy of the back and not the one of the front.

This can only be achieved with cabinets that incorporate independent delay units on their DSP, as the S218W.

**Fig. 2.** Cardioid pattern

**1.3.4. Configuration with with 3 units**

The S218W can generate an uncompromised cardioid behaviour, which means that there is no need for special cabinets, enabling the use of the system’s full efficiency with just “one finger”. In its minimum and standard configuration a cardioid setup consists of a horizontal line of three subwoofer cabinets. Only one subwoofer is needed to compensate for the energy of the other two radiating to the front. Then, the cabinet facing to the back (to the stage) should be located in the centre of the line.

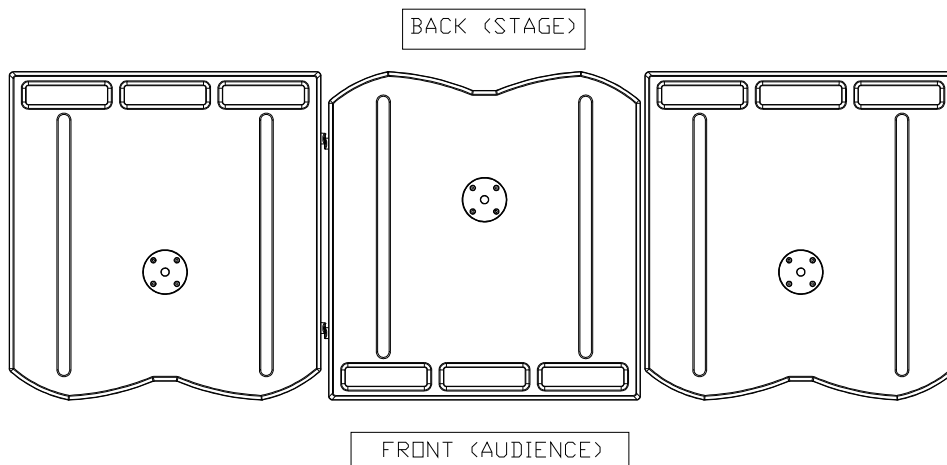

**Fig. 3.** Cardioid configuration for S218W subwoofer (3 units)



The cardioid preset must only be applied to the rear facing subwoofers (**BACK STAGE**). The front facing subwoofers (**FRONT AUDIENCE**) must use the corresponding front-facing preset, as shown in the table below:

S218W Preset (BACK STAGE)	S218W Preset (FRONT AUDIENCE)	Top box model
CARD80 STANDARD	LPF80 STANDARD	Generic, HPF 80 Hz
CARD90 STANDARD	LPF90 STANDARD	Generic, HPF 90 Hz
CARD100 STANDARD	LPF100 STANDARD	Generic, HPF 100 Hz
CARD S-ALIGNED	S-ALIGNED	S26 / S10 / S12 / S15, HPF90 Hz

**Fig. 4.** Correspondence of rear and front presets for cardioid applications

When placing the subwoofers in a cardioid configuration keep a distance to walls of at least 60 cm in order not to affect the radiation of the central reversed cabinet.

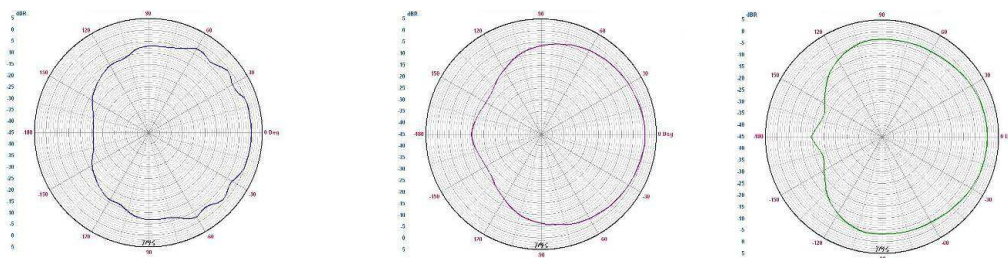

**Fig. 5.** Back energy rejection at 40 Hz / 50 Hz / 63 Hz

**2. CONTROL AND CONNECTION PANEL**

The S218W control panel contains the following elements:



**Fig. 6.** S218W control and connection panel

**A) TOUCHSCREEN:** Displays information about the system status: current preset, amplifier status and signal input level. Allows the user to configure the system: Preset selection, Delay, Gain, Limiter, polarity, ECO mode on/off, Front LEDs on/off, etc. For more information about the available functionality, read the Annex I of this manual.

**NOTE:** For preventing the access to Main Menu with a PIN pattern, please refer to Annex I.

**B) MODEL DATA:** The basic data of the model is found here:

- Model reference
- Average current draw (A)

**C) BALANCED INPUT/LINK:**

XLR-3 Female balanced signal connector for signal input.

XLR-3 Male connector for parallel connection of various cabinets with the same input signal.

Nominal Input sensitivity: +2dBu (1 Vrms)

Maximum Input Voltage without clipping: +14dBu (4Vrms)

Maximum Input Voltage: +20dBu (8Vrms)



**IMPORTANT:** Please always use balanced microphone cable with the following pin assignment: 1= Shield (Ground) 2= Live (+) 3= Return (-)

**D) AC MAINS INPUT/LINK:** Mains supply connection via PowerCon.

- Blue connector for AC in.
- Grey connector to feed other units in parallel. Linking up to four units is possible, if a quality cable of a minimum section of 3x2.5mm<sup>2</sup> is used. Connecting more than four units in parallel may lead to a voltage drop in the cable that will reduce the equipment performance.



Always use mains power cable supplied by manufacturer. Never connect NÍTID cabinets to an unearthed mains supply or by using an unearthed mains cable

**E) AUTHENTICATION QR CODE:** This QR code is a smart label that ensures that the product is an original Amate Audio product. To verify the authenticity, please follow the instructions in the following link:

<http://www.amateaudio.com/en/product-authentication/>

**3. CONFIGURATIONS****3.1. Parallel connection**

Connect the signal (mixing desk output) to INPUT on the first unit. Use the LINK output to transfer the INPUT signal to the second unit and thus sequentially for further units. All of the units in this chain must be switched on.

For the mains connection use the cable with the blue PowerCon. You can use the mains connection in parallel by using a cable with grey PowerCon at one end and the blue PowerCon at the other end.

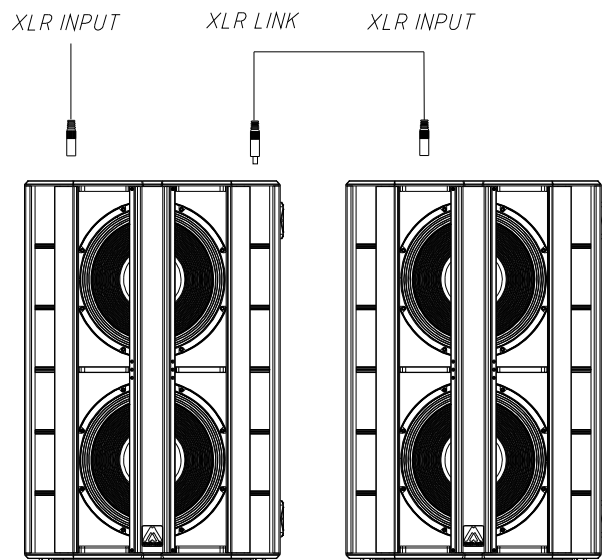

**Fig. 7.** Parallel connection for S218W cabinets (signal and mains)



Do not connect NÍTID series units using PowerCon without earth.  
Do not connect more than four units using the AC output link connector.

### 3.2. Parallel connection with other equipment

You can connect other NÍTID S full-range loudspeakers in parallel with the S218W. Please, follow the same parameters as explained in Fig. 7.

## 4. MOUNTING AND PLACEMENT

For a proper installation of the acoustic cabinet systems, it is strongly recommended to carefully read the following advices.

### 4.1. S218W with full-range systems

The S218W incorporates an M20 base-plate on its upper side for the attachment of a standard 35 mm diameter bar.

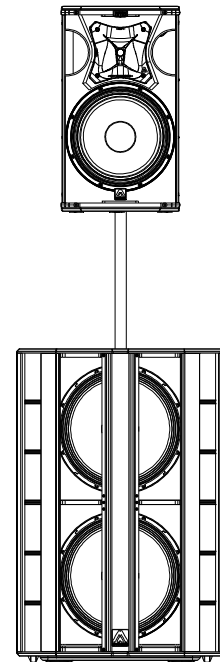
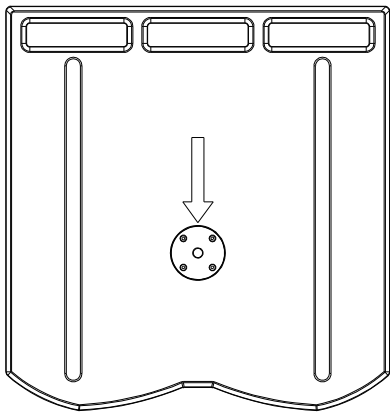

Fig. 8. S218W socket

## 5. SPECIAL DSP FEATURES

### RMS Limiter

NITID systems combine a carefully designed dual limiter system to independently protect each transducer against power overload: a peak Limiter and a RMS Limiter.

The RMS Limiter prevents long term exposition of the transducer to high RMS levels (abnormal when the music has a correct dynamic headroom). When the limiter indicator (see NOTE) lights up continuously, it means that the RMS limiter is active. On the other hand, the Peak Limiter has an ultrafast attack to control the highest peaks of the music and only makes the indicator blink.

Thanks to the large experience of Amate Audio on DSP algorithms and limiters, these limiters are highly effective yet unnoticeable for the listener.

**NOTE:** in the NÍTID-S systems, the limiter indicator can be found in the rear screen, with the words **LIM** highlighted in orange when it is active. Alternatively, the front NITID logo can be configured to indicate the limiter (see Annex I for more information).



## Automatic Temperature Limiter

Under normal operation, NITID amplifiers can perform during many hours at full power. However, should the temperature in the amplifier rise abnormally, the system will automatically adjust the limiter threshold as a temporal protection to prevent the temperature rising further.

When the temperature lowers again, the system will recover its normal operation. Should the temperature continue rising and reach 90°C at the amplifier's heatsink, the system will shut down in Protection mode.

## Input Dynamic Compressor

NITID systems have a nominal input voltage of +8dBu / 2V (+2dBu / 1V in subwoofers) for full power performance; nevertheless, in order to respect the highest dynamics of the music, the input is capable to hold a high input voltage (+20dBu / 8V). This avoids undesirable effects from sound sources and mixers capable of delivering a higher output voltage.

It must be noticed that **driving a system continuously over its nominal input level may drastically decrease the sound quality**, normally because of the lack of headroom (dynamic response). In the long term, it might also produce unnecessary damaging of the transducers and reduce their reliability. The **maximum power of the system** is obtained at its **nominal input level**. Under this condition, the limiter indicator may blink occasionally. Working continuously above this level is never translated into better results.

To avoid loudspeaker damage because of input overload issues, NITID systems build in an **input monitoring system that prevents the cabinet from being continuously operated at excessive input signal levels**.

After a period of exposure to high average input levels (over +2.5Vrms), a dynamic compressor will **progressively reduce the output power**, to protect the transducers.

The higher the voltage at the input is, the higher the reduction of the output power, being maximum reduction 18dB. While the dynamic compressor is active, the message "Input Overload" will be present on the rear screen and the front logo will blink constantly.

To get back to the normal operation mode, the input level should be reduced to below 2 Vrms. After the level reduction, the system needs about 5 seconds to recover the normal operation mode.

levels below half of its rated program power. In the range between -6dB and 0dB in respect to the nominal input, the **ALC** will not modify the response.

## 6. TROUBLESHOOTING

### System not powering up

- If the screen does not light up:
  - Check that the PowerCon cable is correctly inserted and turned until the "click",
  - Check that the AC mains is between the rated AC (85 to 265 VAC)
  - If AC is correct, the power module might need servicing. Contact support.

- If the screen lights up, but remains with the Amate Audio logo, the DSP board might need servicing. Contact support.

### **No output sound**

- Check in the screen that the input bar shows level being received by the system. If not, check your cabling and sound sources.
- Check that the signal cables are in good condition and connected at both ends
- The mixer output level must not be at minimum.
- Check that the mixer channel is not muted.
- Check that the system is not in MUTE or STANDBY (click the thermometer icon and read the “Status” value) not lit. If yes, go inside the menu using the touchscreen and deactivate them:
  - To disable the Standby go to SETUP and select PWR ON in the ECO button.
  - To disable the MUTE push the icon with a loudspeaker.
- Check that the system GAIN is not set to the minimum. To do that, go to the AUDIO setting using the touchscreen, select GAIN and move the slider to the 0 dB position.

### **Distorted output signal**

- The system is being saturated with a very high input signal, frequently caused by the same mixer. Check the output level or mixer gain channels.

### **Poor bass levels**

- Check the polarity on the signal connections between the mixer and cabinets. If any of the Pins (1, 2 or 3) have been inverted at the cable ends, this will cause significant performance and sound quality loss.

### **Noise and Hum**

- Check that all the connections to the active units are in good condition.
- Avoid intertwining between mains supply cables or proximity to transformers or Electromagnetic (EMI) emitting devices.
- Check there is no light intensity regulator in the same AC circuit as the unit. ALWAYS connect the sound and light circuits in different phases.
- Check that there is a proper connection to EARTH in the electrical installation.

### **Forgotten pattern for Touchscreen**

- Check the annex at the end of this manual to learn the default pattern.
- Should you have changed the pattern and forgotten it, follow these steps:
  - Turn the system off.
  - Turn the system on.
  - When the display shows Amate Audio logo and the firmware version, press anywhere on the touch screen until the screen changes to the main screen.
  - The pattern will be restored to its default value.

## 7. TECHNICAL FEATURES

	<b>S218W</b>
<b>Analog Audio Input</b>	
Sensitivity	+2dBu – 1 V
Impedance	50kΩ balanced
<b>Mains Supply</b>	
Type	Univ. switch mode power supply
Nominal input	85-265 VAC/45-65 Hz
Average current draw	4.5 A
<b>AD/DA converters</b>	24 bit / 48 kHz
<b>DSP architecture</b>	64 bit
<b>Frequency response (-10 dB)</b>	30 Hz – 130 Hz (LPF100)
<b>Maximum output level (1m/continuous)</b>	137 dB
<b>Amplifier (program)</b>	2500 W
<b>Nominal directivity (-6dB)</b>	omnidirectional
<b>Components</b>	
LF-MF	2x18" woofers (4" voice coil)
<b>Cabinet</b>	
Type	Bass-reflex
Height	1116 mm
Width	750 mm
Depth	780 mm
Weight (net)	112 Kg
Connectors	2 x AC PowerCon (input, link) 2 x XLR (input, link)
Material	Multilayer birch plywood, 2 mm powder coated steel front grilles with black acoustic mesh
Finish	Hi-resistance black Polyurea coating

**Note:** Specifications subjected to change without prior notice.

## ANNEX I: TOUCHSCREEN OPERATION

Amate Audio’s Nítid S series comes with integrated signal processing (Internal DSP). The internal DSP can be tuned using the touchscreen. The main specs of the touchscreen are:

- TFT-LCD screen
- 320x240 pixels resolution
- Vision angle 180°
- 16.7 Million of colours



### 1. Main screen

After turning on the system, a first loading screen show up the Amate Audio’s logo. The built-in gyroscope can adapt the orientation of the screen elements to the loudspeaker position.

When the boot process is completed, the following elements are shown:

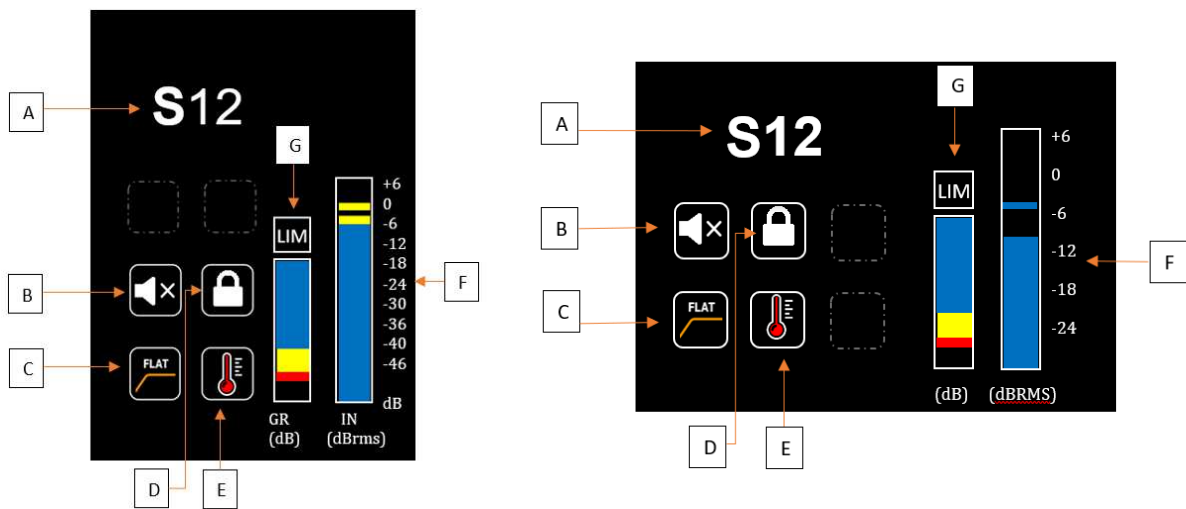

- A. Loudspeaker model
- B. Mute button

It mutes the audio output without turning off the amplification stage, so when the process is reverted the speaker delivers the audio immediately.

### C. Preset button

Quick access to the preset selection menu. The icon gives info at a first glance: It shows what preset is currently applying.

### D. Main menu button / Unlocking

It gives access to the Main menu (Unit settings). When the unit is unlocked, the button shows the icon of a gear.

The pattern can be customized inside Pin configuration menu:

Menu button (**D**) → Settings → PIN

### E. Info button

Info button is dynamic, meaning that it changes according to the unit's status. The button shows current temperature with three colours: Blue when temperature is below 55°, orange between 55°-75° and red above 75°. In the case the unit enters in protect, the icon flickers.

Click on the Info button to access to detailed unit info.

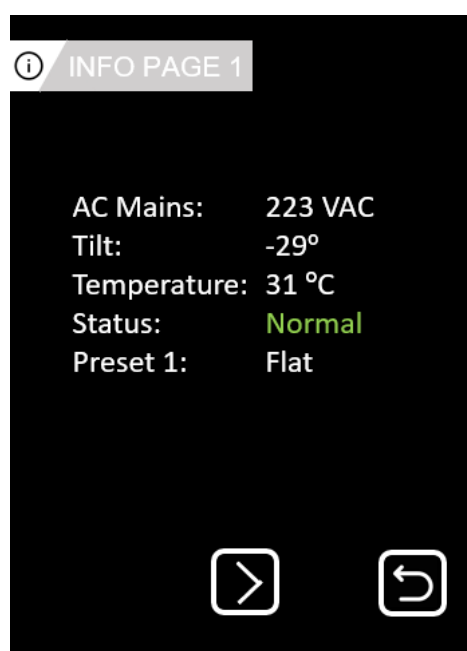

Info menu has four pages. In the first page, Status summarizes the unit status with the following options:

- Normal: Normal behaviour
- Mute: Mute is enabled
- Standby: The unit is waiting for signal
- Protect: Failure in the amplification stage

The tilt indication is not available in the presence of signal at the input. The vibration caused by the sound waves jeopardize the measurement.

#### F. Input level meter

It shows the relative to full-scale level in the XLR inputs of the unit. The reference is the sensibility of the loudspeaker, available in the specs, plus 6 dB of headroom. In the case the signal reaches saturation, a red clipping indicator show-up.

#### G. Limiter check. Gain reduction level meter.

The limiter check box (LIM box) turns on when the integrated signal limiter is working. Below the limiter check box is located the Gain reduction level meter that shows the level of limiter applied to the input signal.

## 2. Main menu

With the unit unlocked, push on the Gear icon to access Main menu.

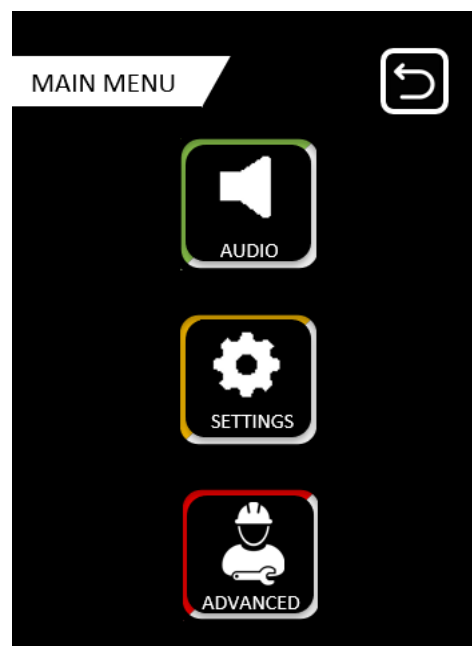

- **Audio**  
Audio signal settings.
- **Settings**  
Non-audio settings.
- **Advanced**  
Advanced configuration parameters enabled for qualified users.

## 2.1. Audio menu



- **Preset**  
Factory preset selection  

When loading a preset with a set of audio parameters (EQ, delay,...) customised by the user, a pop-up will show up asking for confirmation to hold the user audio parameters. Accepting to hold the user parameters makes them overload the chosen preset. Cancelling to hold the user parameters delete all the user parameters only applying the preset.
- **Gain**  
Input gain control. The fader select the gain reduction applied to the input signal.
- **Limiter**  
Built-in limiter threshold control. The level meter shows the current gain reduction applied to the input signal. Lower the threshold to increase the compression.
- **Delay**  
Input signal delay control. It can be set both in milliseconds and in meters, showing the equivalence in the other box. There is a polarity control button.
- **EQ**  
Input parametric multiband equalizer control. There are available five parametric peaking filters.  
Pushing on the upper-right corner gear enables the advanced eq menu, where each parametric can be customized for frequency, gain, bandwidth. There is an option to bypass each filter.

On the top right corner of the Advanced EQ menu, you can find the EQ reset button. When pushed, all values of the five available EQ will be set back to factory default (no EQ). The system will ask for confirmation before performing this operation with an on-screen window. Select OK to proceed.

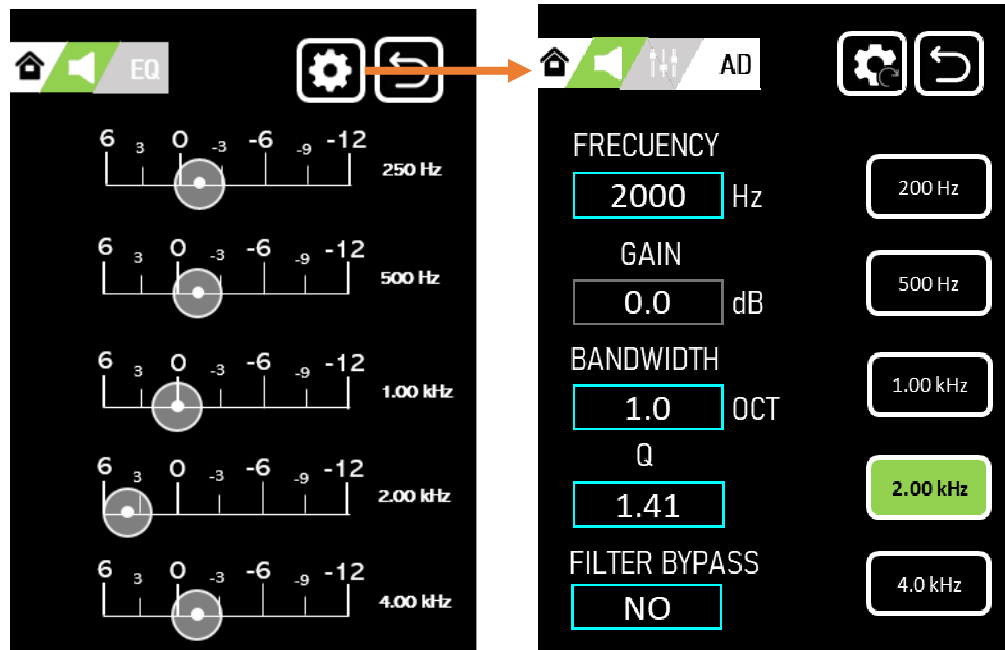

- **Save**  
Access to the internal unit memory. Each of the 24 available memories can store a new user customized preset, saving: EQ, delay, gain and limiter configurations.

2.2. Settings menu

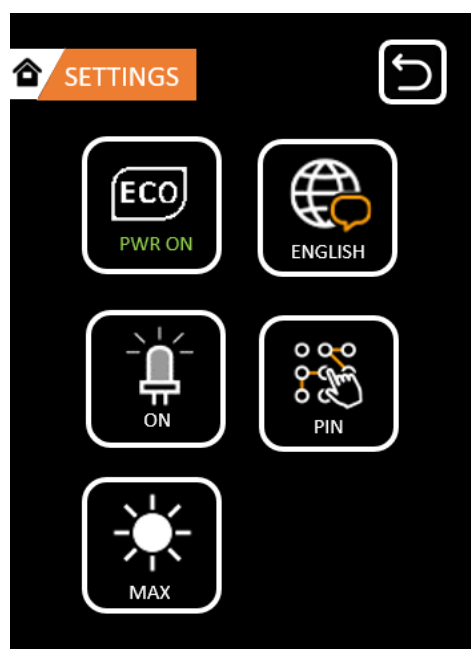



- **ECO**  
Amplifier stage power behaviour configuration.  
**PWR ON:** The amplifier stage is always active at full power for a quick amplified signal delivery.  
**STANDBY:** The amplifier stage power is in standby mode, so no signal output though the unit is active.  
**AUTO:** The amplifier stage waits in standby mode for an input audio signal. When this happens the amplifier stage switch to PWR ON.
- **Frontal LED**  
Frontal Nitid LED configuration. The options are:  
**OFF:** LED always off.  
**ON:** LED always on  
**LIM ON:** LED remains off until internal limiter starts working that makes LED lights on.  
**LIM OFF:** LED remain on until internal limiter starts working that makes LED turns off.
- **Screen brightness**  
Backlight intensity configuration. There are three possible levels of brightness intensity.
- **Language**  
Language selection for the unit. The available languages are English, Spanish and Catalan.
- **PIN**  
Pattern PIN configuration as a drawing connecting several points

The unlocking process is performed drawing a pattern. The pattern is configured inside Settings menu. By default, the pattern is (starting on the bottom left dot, then clockwise):

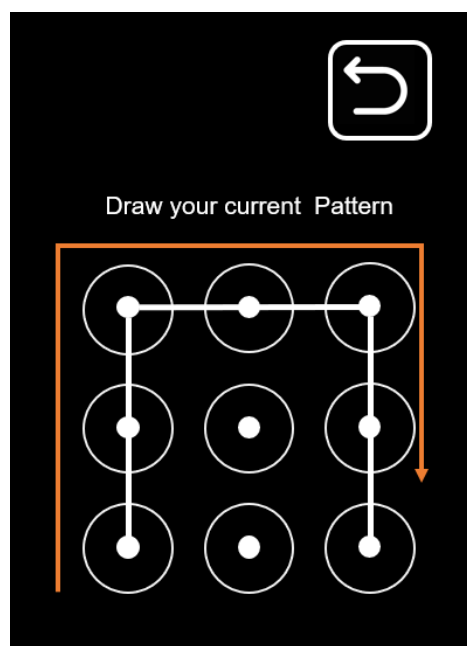

Once the previous pattern is draw, the system will wait for the new pattern. A lock icon in the upper left corner of the screen will show up. Pushing on it locks the unit (The system confirms the operation swapping the lock icon for a closed lock). Once the operation is completed, the system will confirm the selection. Exit from the PIN menu to start the locking process. The unit will lock after waiting for 1 minute or after a cycling the power.

The pattern PIN can be reset anytime. Just hold the finger on the screen when unit boots on the Amate Audio logo. When boot finish the pattern have been reset to default.

### 2.3. Advanced menu

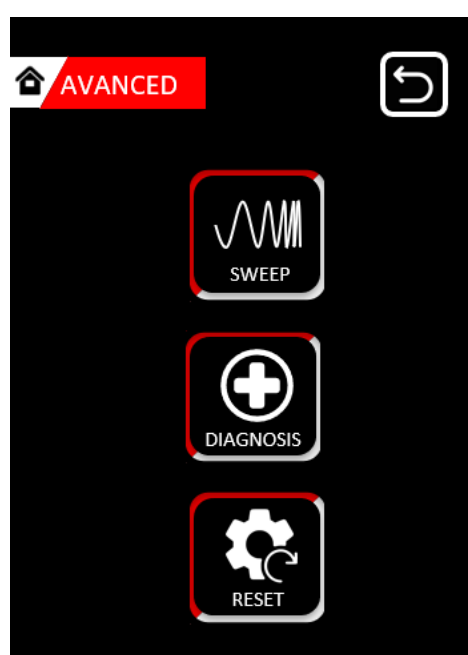

- **Sweep**  
Acoustic test. A sinusoidal soundwave is played. It sweep through the entire audible range in two steps. First, the high frequency stage from the cutoff frequency to 20 kHz. Then, the low frequency stage from 20 Hz to the cutoff frequency. The duration of both sweep are approximately two seconds.
- **Diagnosis**  
Access to the system info menu. It is equivalent to push the thermometer icon from Main screen.
- **Reset**  
Factory reset of all the unit's parameters. The pattern PIN must be entered to confirm the process.

# DECLARATION OF CONFORMITY

In accordance with EN 45014:1998

Manufacturer's Name: "AMATE AUDIO S.L."  
Manufacturer's Address: C/ Perpinyà 25, Polígon Industrial Nord  
08226 Terrassa, (Barcelona), SPAIN  
Brand: "AMATE AUDIO"

We declare under our own responsibility that:

Product: Active speaker systems with DSP. Audio apparatus for professional use  
Name: Nítid S218W

Conforms to the following product specifications:

Safety: IEC 60065-01 + A1  
EMC: EN 55022:2006  
EN 55103-1:2009  
EN 55103-2 2009  
FCC Part 15

WARNING:

In accordance to EN55022, this is a class A product. In a domestic environment, this product may cause radio interference in which case the user may be required to take adequate measures.

Supplementary Information

The product herewith complies with the requirements of the:

Low Voltage Directive 2006/95/EC  
EMC Directive 2004/108/EC  
RoHS Directive 2002/95/EC  
WEEE Directive 2002/96/EC

With regard to Directive 2005/32/EC and EC Regulation 1275/2008 of 17 December 2008, this product is designed, produced, and classified as Professional Audio Equipment and thus is exempt from this Directive.

Date of issue: February 1rst, 2024

Signature:

**AMATE AUDIO S.L.**  
N.I.F: B5903481  
Violinista Vellutó, 18  
Tel: +34 93 731 12 34  
08222 - Terrassa  
Barcelona - SPAIN



**Joan A. Amate Martinez**  
General

Conformity Marking



*Great sound  
from Barcelona  
since 1972*

---

The **NÍTID** powered loudspeaker systems have been  
designed, engineered and manufactured in  
Barcelona – SPAIN by

---

**Amate Audio S.L.**

Perpinyà, 25 · Polígon Industrial Nord · 08226 Terrassa  
T. +34 93 735 65 65 – F. +34 93 735 60 48 –  
info@amateaudio.com

R&D and FACTORY:  
Violinista Vellsolà, 18 · 08222 Terrassa  
T. +34 93 736 23 90 – F. +34 93 786 47 00

**Barcelona – SPAIN**

---

[www.amateaudio.com](http://www.amateaudio.com)